

Makro-Grip® 46, Étau 5 axes

Largeur des mors 46 mm, Plage de serrage 0 - 65 mm

Item No. 48065-46



Plage de Serrage	0 - 65 mm
Dimensions	77 x 77 x 65 mm
Principe de Serrage	à engagement positif / par adhérence
Type de Composant	cubique
Conditionnement	1 Pièce
Poids	1.75 kg
Matériau	Acier

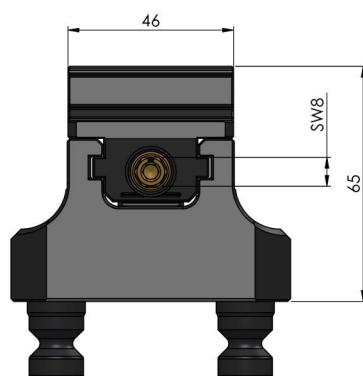
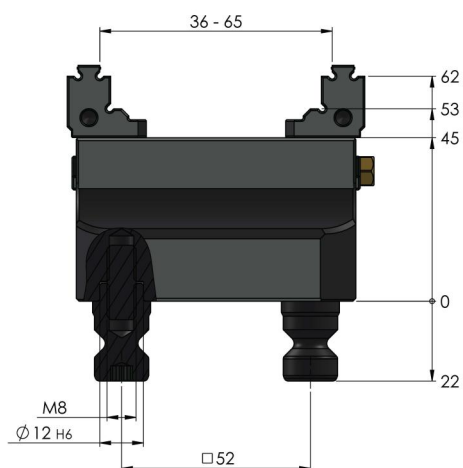

Makro-Grip® 46, Étau 5 axes

Largeur des mors 46 mm, Plage de serrage 0 - 65 mm

Item No. 48065-46

