

Makro-Grip® FS 125, Étau 5 axes

Largeur des mors 77 mm, Plage de serrage 0 - 205 mm, avec denture complète

Item No. 48205-77 FS

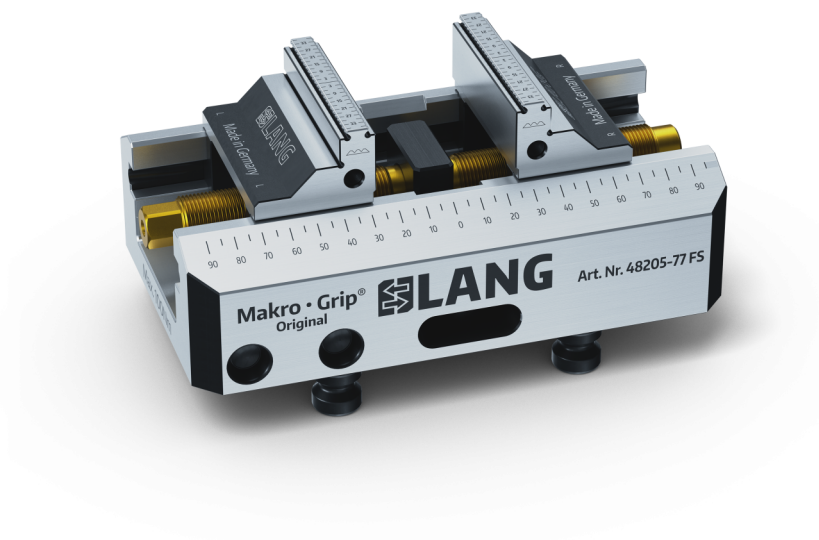

Plage de Serrage	0 - 205 mm
Dimensions	210 x 125 x 89 mm
Principe de Serrage	à engagement positif / par adhérence
Type de Composant	cubique
Conditionnement	1 Pièce
Poids	9.1 kg
Matériau	Acier

Makro-Grip® FS 125, Étau 5 axes

Largeur des mors 77 mm, Plage de serrage 0 - 205 mm, avec denture complète

Item No. 48205-77 FS

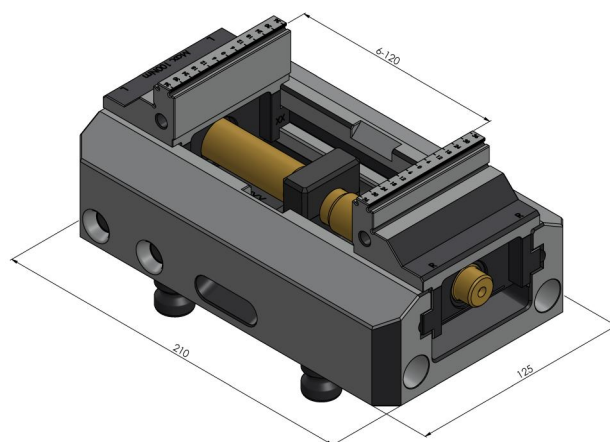
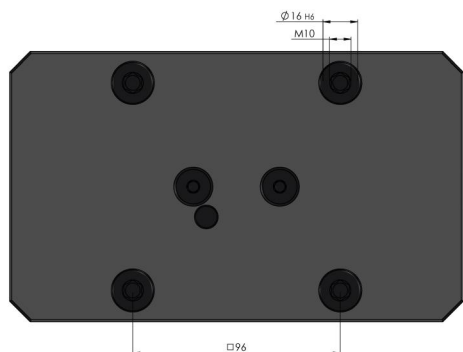

Makro-Grip® FS 125, Étau 5 axes

Largeur des mors 77 mm, Plage de serrage 0 - 205 mm, avec denture complète

Item No. 48205-77 FS

